

P/2 DA2xi

P/2 DA2xi MT

TWO OUTPUT VGA-QXGA
DISTRIBUTION AMPLIFIERS

- 350 MHz (-3 dB) RGB bandwidth, fully loaded
- Gain and peaking switch
- Selectable sync impedance
- Power and source signal indicator
- Includes detachable 6' (2 m) male-to-male VGA input cable
- DDC signal pass-through
- Active PC Audio interfacing – P/2 DA2xi MT only



P/2 DA2xi



P/2 DA2xi MT

The Extron P/2 DA2xi and P/2 DA2xi MT are one input, two output, high performance distribution amplifiers. They are available in compact and durable metal enclosures which can be easily installed in small, tight places. They are even portable enough to fit into a briefcase for presenters on-the-go.



Extron® Electronics
www.extron.com

DESCRIPTION

The Extron P/2 DA2xi and P/2 DA2xi MT are one input, two output, high resolution VGA-QXGA distribution amplifiers. Available in compact and durable metal enclosures, these units can be easily installed in small, tight places. They are even portable enough to fit into a briefcase for presenters on-the-go. They offer 350 MHz (-3 dB) RGB video bandwidth and are compatible with VGA-QXGA graphic cards, monitors, and projectors. Gain, peaking, and sync impedance are DIP switch selectable.

Housed in quarter rack width enclosures, the flexible P/2 DA2xi and P/2 DA2xi MT can be combined with a variety of mounting options to meet the requirements of virtually any application or environment. Utilizing an optional VersaTools® or Universal Rack Shelf Kit, the P/2 DA2xi and P/2 DA2xi MT can be rack-mounted alone or with three other quarter rack width A/V products. Additional mounting kits are available so these systems can be mounted under a desk or next to a projector.

FEATURES

- **Bandwidth** – 350 MHz (-3 dB) RGB bandwidth, fully loaded.
- **Gain and peaking switch** – Provides various levels of signal boost to maintain video signal integrity over long cable runs.
- **Selectable sync impedance** – Sync impedance can be set via DIP-switch for optimum compatibility with various laptop computers.
- **Power and source signal indicator** – A dual color LED illuminates yellow to indicate power, and green to indicate that a signal is present at the input.
- **DDC signal pass-through** – DDC information is routed from the input to the local monitor output. DDC pass-through ensures that the display connected to the local monitor output is able to communicate with the computer graphics card, providing information about its maximum resolution capability and optimal resolution.
- **Rack-mountable or portable**
- **External international power supply** – An autoswitchable power supply is included.
- **Extron input cable(s) included** – The P/2 DA2xi comes with one detachable, high performance, Extron six foot male to male VGA cable, while the P/2 DA2xi MT comes with one detachable six foot male to male VGA with audio cable.



Includes Extron VGA with Audio Cable

MOUNTING OPTIONS

Because the P/2 DA2xi and P/2 DA2xi MT are housed in quarter rack width metal enclosures, there are a number of versatile mounting options available to suit virtually any application or environment. With an optional VersaTools or Universal Rack Shelf Kit, either model can be rack-mounted alone or with three other quarter rack width A/V products. There are also optional mounting kits available so the P/2 DA2xi and P/2 DA2xi MT can be mounted under a desk or next to a projector (see mounting options diagrams below).

Rack Mount

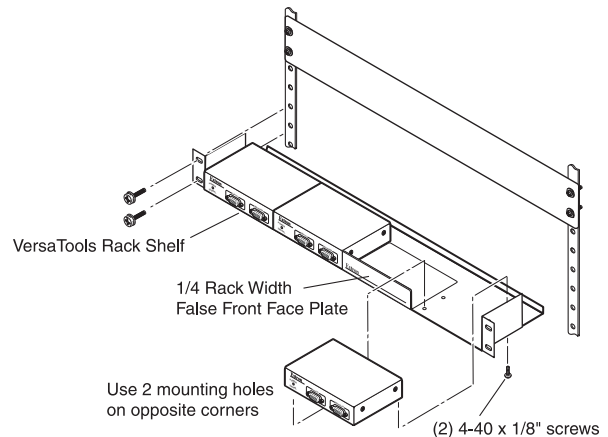

Under Desk Mount

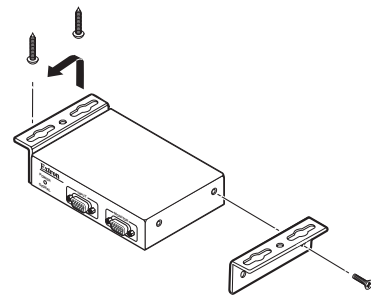

Projector Mount

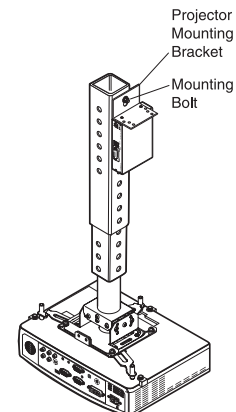

| VIDEO | |
|-----------------------------|--|
| Gain | |
| P/2 DA2xi | Output: 0 dB or 0.4 dB, selectable Local monitor output: unity |
| P/2 DA2xi MT | Output: 0 dB or 0.6 dB, selectable Local monitor output: unity |
| Peaking | |
| P/2 DA2xi | Output: selectable, 0.7 dB or 1.4 dB at 100 MHz |
| Local monitor output: fixed | |
| P/2 DA2xi MT | Output: selectable, 0 dB or 0.6 dB at 100 MHz Local monitor output: fixed |
| Bandwidth | 350 MHz (-3 dB) |

| VIDEO INPUT | |
|----------------------------|--|
| Number/signal type | 1 VGA-QXGA RGBHV, RGBS, RGSB, RsGsBs |
| Connectors | (1) 15-pin HD female |
| Nominal level | 0.7 Vp-p for RGB |
| Minimum/maximum levels | Analog, 0.3 V to 1.5 Vp-p with no offset at unity gain |
| Impedance | 75 ohms |
| Horizontal frequency | 15 kHz to 135 kHz |
| Vertical frequency | 30 Hz to 170 Hz |
| Return loss | <-38 dB @ 5 MHz |
| DC offset (max. allowable) | 1.0 V |
| Input coupling | DC |

| VIDEO OUTPUT | |
|------------------------|---|
| Number/signal type | 1 VGA-QXGA RGBHV, RGBS, RGSB, RsGsBs 1 VGA-QXGA RGBHV, RGBS, RGSB, RsGsBs local monitor loop-through (i.d. bits are passed through) |
| Connectors | (2) 15-pin HD female |
| Nominal level | 0.7 Vp-p for RGB at unity gain |
| Minimum/maximum levels | Analog, 0.3 V to 1.5 Vp-p (follows input) |
| Impedance | 75 ohms |
| Return loss | <-40 dB @ 5 MHz |
| DC offset | ±5 mV with input at 0 offset |

| SYNC | |
|------------------------|---|
| Input type | RGBHV, RGBS, RGSB, RsGsBs |
| Output type | RGBHV, RGBS, RGSB, RsGsBs |
| Input level | 1.5 V to 5.0 Vp-p |
| Output level | TTL, 5 Vp-p, unterminated |
| Input impedance | |
| P/2 DA2xi | <1k ohm (default) or 10k ohms, selectable |
| P/2 DA2xi MT | 510 ohms (fixed) |
| Output impedance | 75 ohms (default) or 50 ohms, selectable |
| Max. propagation delay | 60 ns |
| Max. rise/fall time | 4 ns |
| Polarity | Positive or negative (follows input) |

| AUDIO — P/2 DA2XI MT | |
|-----------------------------|--|
| Gain | Unbalanced output: 0 dB; balanced output: +6 dB |
| Frequency response | 20 Hz to 20 kHz, +0.05 dB, -0.1 dB |
| THD + Noise | 0.03% @ 1 kHz at nominal level |
| S/N | >90 dB (balanced) at maximum output |
| Crosstalk | <-80 dB @ 1 kHz, fully loaded |
| Stereo channel separation | >80 dB @ 1 kHz, >60 dB @ 20 kHz |
| CMRR | >67 dB @ 20 Hz to 20 kHz |

| AUDIO INPUT — P/2 DA2XI MT | |
|-----------------------------------|---|
| Number/signal type | 1 stereo, unbalanced |
| Connectors | (1) 3.5 mm stereo jack, female; tip (L), ring (R), sleeve (GND) |
| Impedance | >18k ohms unbalanced, DC coupled |
| Nominal level | -10 dBV (316 mV) |
| Maximum level | >+10 dBV (3.16 V) (unbalanced) at 1%THD+N |

NOTE: 0 dBu = 0.775 Vrms, 0 dBV = 1 Vrms, 0 dBV ≈ 2 dBu

| AUDIO OUTPUT — P/2 DA2XI MT | |
|------------------------------------|---|
| Number/signal type | 1 stereo, balanced/unbalanced |
| Connectors | (1) 3.5 mm captive screw connector, 5 pole |
| Impedance | 50 ohms unbalanced, 100 ohms balanced |
| Gain error | ±0.1 dB channel to channel |
| Nominal level | -2 dBu (632 mV) balanced output -10 dBV (316 mV) unbalanced output |
| Maximum level (Hi-Z) | >+15 dBu (4.36 V), balanced at 1% THD+N |
| Maximum level (600 ohms) | >+9 dBm (2.18 V), balanced at 1% THD+N |

| GENERAL | |
|--------------------------|--|
| External power supply | 100 VAC to 240 VAC, 50/60 Hz, 4.5 watts, external, autoswitchable; to 12 VDC, 1 A |
| Power input requirements | 12 VDC, 0.2 A |
| Temperature/humidity | Storage: -40 to +158 °F (-40 to +70 °C) / 10% to 90%, noncondensing Operating: +32 to +122 °F (0 to +50 °C) / 10% to 90%, noncondensing |
| Rack mount | Yes, with optional 1U rack shelf |
| Enclosure type | Metal |
| Enclosure dimensions | 1.0" H x 4.3" W x 3.0" D (quarter rack wide) 2.5 cm H x 10.9 cm W x 7.6 cm D (Depth excludes connectors.) |
| Product weight | 0.5 lbs (0.3 kg) |
| Shipping weight | 3 lbs (2 kg) |
| Vibration | ISTA 1A in carton (International Safe Transit Association) |
| Listings | UL, CUL |
| Compliances | CE, FCC Class A, VCCI, AS/NZS, ICES |
| MTBF | 30,000 hours |
| Warranty | 3 years parts and labor |

NOTE: All nominal levels are at ±10%.

| Model | Version Description | Part Number |
|-------------|-----------------------|-------------|
| P/2 DA2xi | 1x2 VGA-QXGA | 60-506-03 |
| P2 DA2xi MT | 1x2 VGA-QXGA w/ Audio | 60-506-21 |

| Included Accessories | |
|---|-----------|
| User Guide | |
| Tweaker | |
| Desktop power supply | |
| VGA cable clip | |
| VGA M-M MD/6 - P/2 DA2xi only | 26-238-01 |
| VGA-A M-M MD/6 - P/2 DA2xi MT only | 26-490-02 |
| 5-pin captive screw mating plug - P/2 DA2xi MT only | |

| Optional Accessories | |
|-----------------------------|-----------|
| Versa-Tools rack shelf kit | 60-190-20 |
| Universal rack shelf kit | 60-190-01 |
| Under-desk mounting kit | 70-077-01 |
| Projector mounting kit | 70-077-04 |
| T-VGA adapter | 26-106-01 |
| VGA-A M-M MD/3 | 26-490-01 |
| VGA-A M-M MD/12 | 26-490-03 |

Specifications are subject to change without notice.

APPLICATION DIAGRAMS

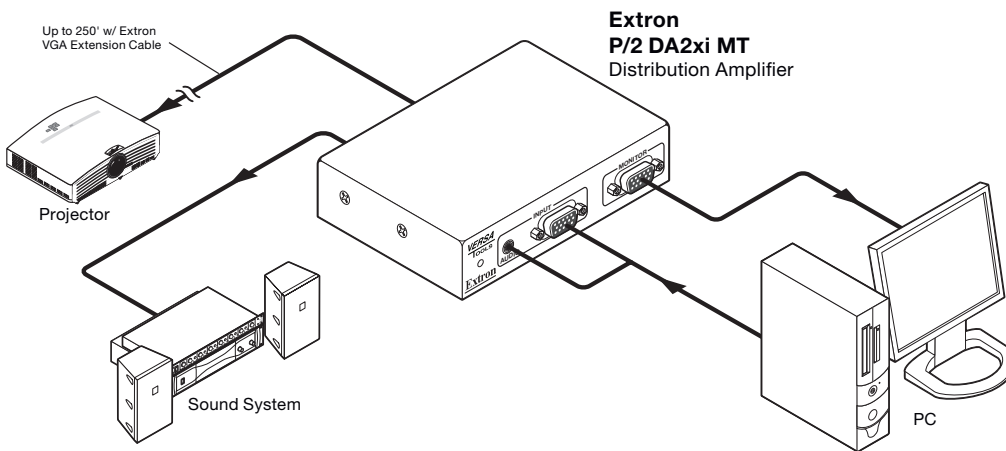
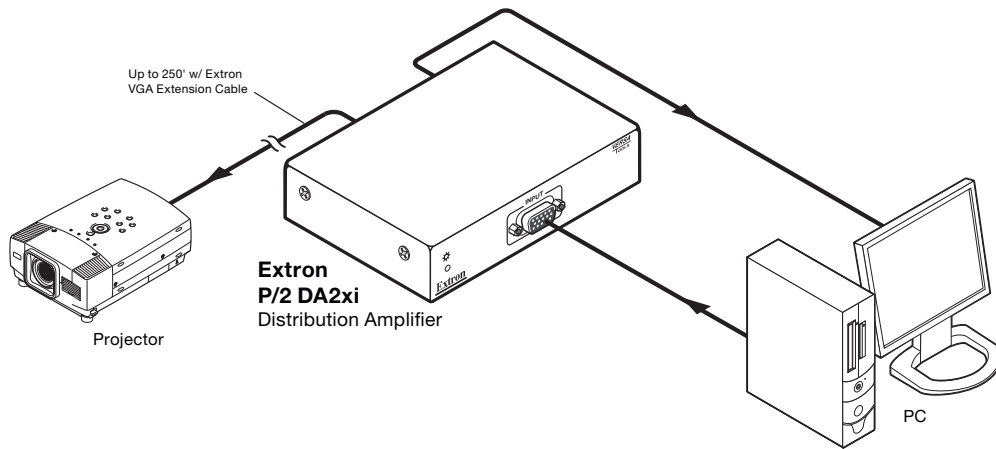

PANEL DRAWINGS

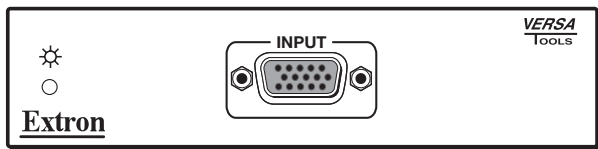

P/2 DA2xi - Front

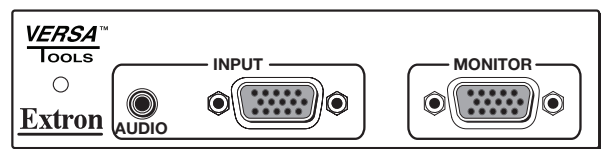

P/2 DA2xi MT - Front

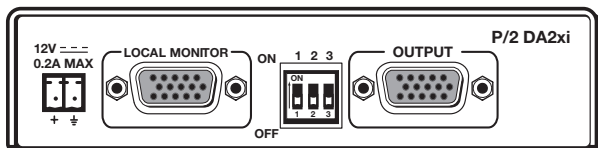

P/2 DA2xi - Back

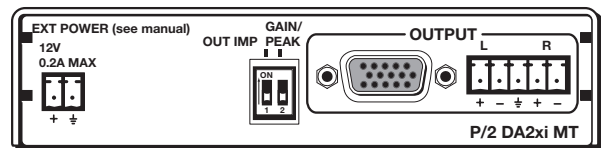

P/2 DA2 xi MT - Back



Extron Electronics, USA
1230 South Lewis Street
Anaheim, CA 92805
800.633.9876 714.491.1500
FAX 714.491.1517

Extron Electronics, Europe
Beeldschermweg 6C, 3821 AH Amersfoort
The Netherlands
+800.3987.6673 +31.33.453.4040
FAX +31.33.453.4050

Extron Electronics, Asia
135 Joo Seng Rd. #04-01
PM Industrial Bldg.
Singapore 368363
+65.6383.4400 FAX +65.6383.4664

Extron Electronics, Japan
Kyodo Building, 16 Ichibancho
Chiyoda-ku, Tokyo 102-0082
Japan
+81.3.3511.7655 FAX +81.3.3511.7656